

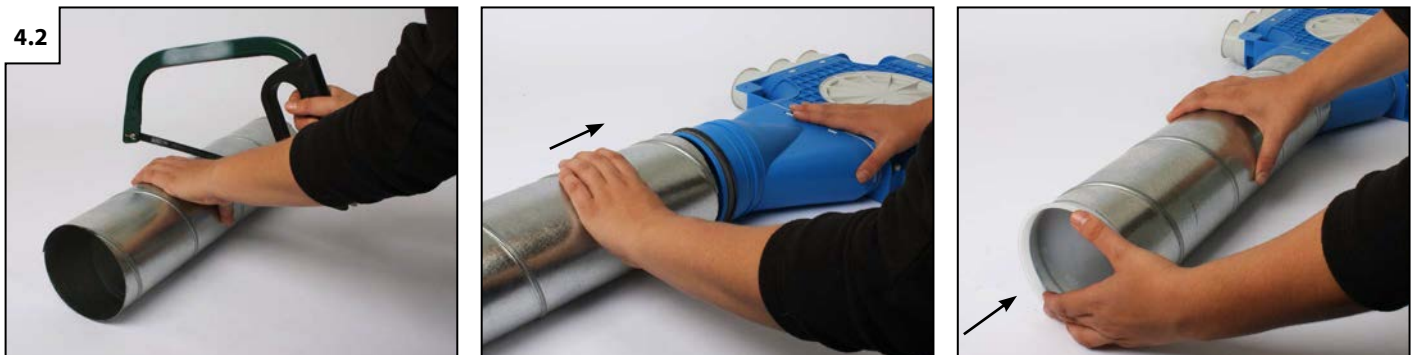

# Uniflex plus +

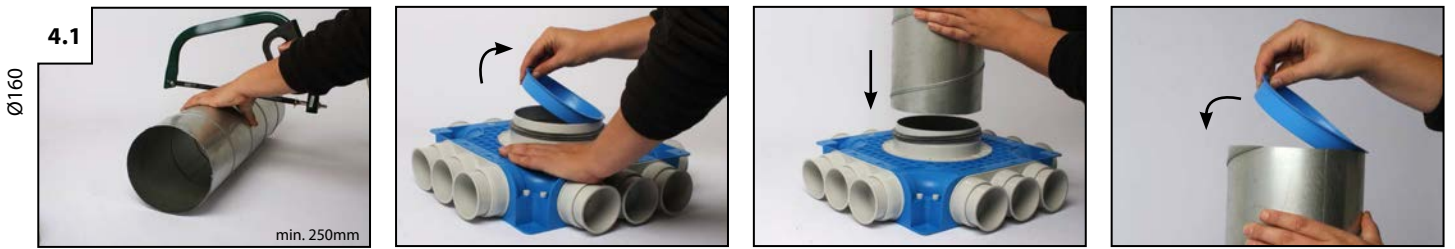

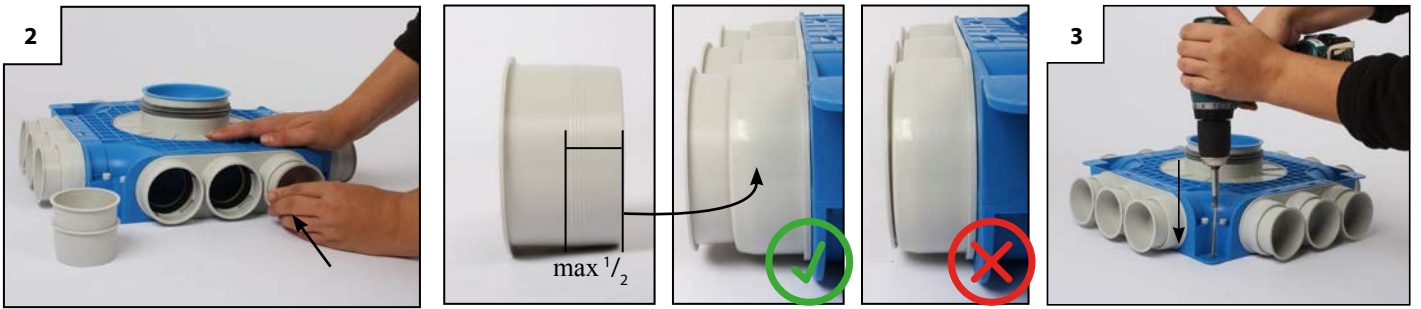
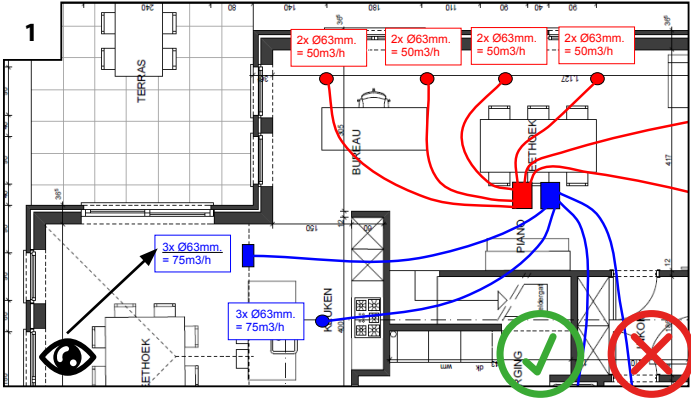
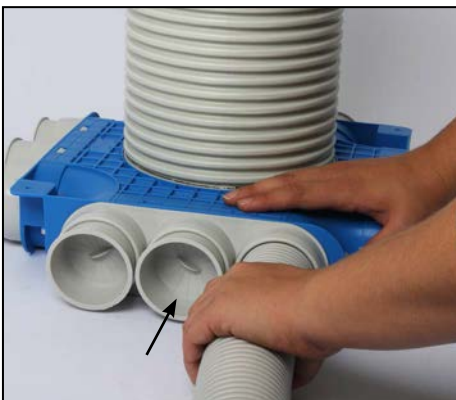
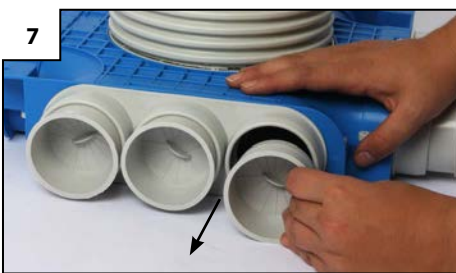
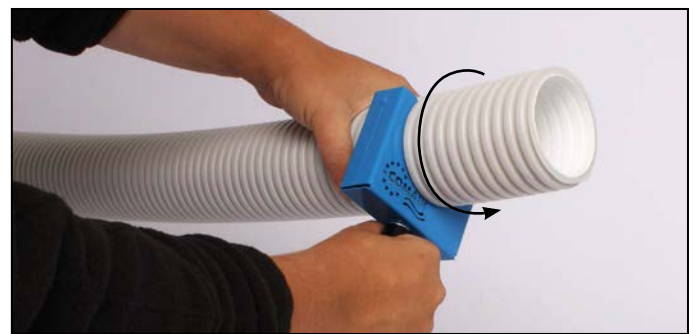
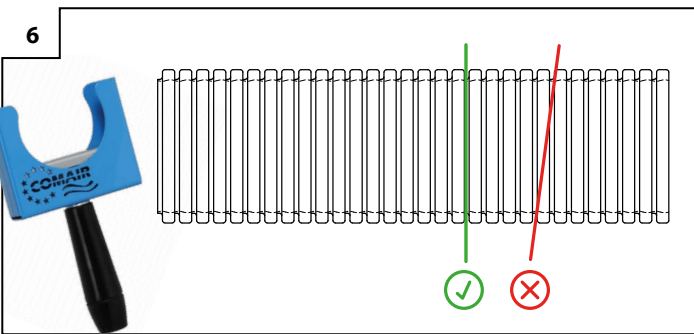
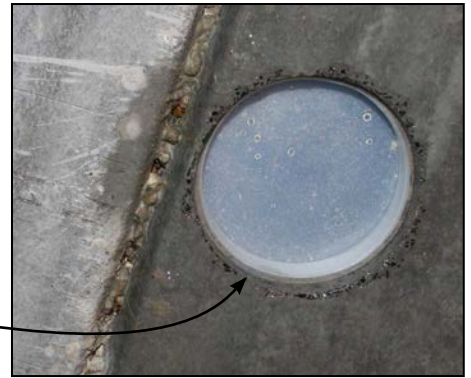
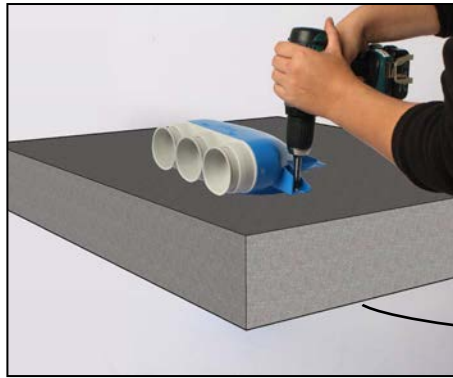
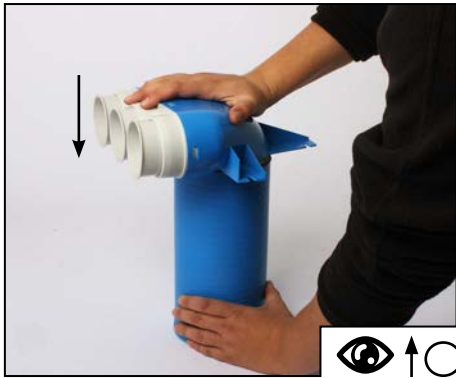
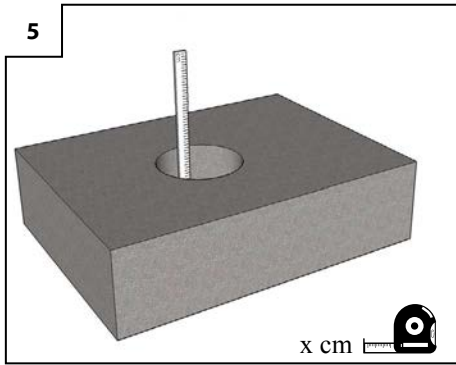

$\text{Ø}50\text{mm} =$    $+ 2x \text{ click!}$   
 $\text{Ø}63\text{mm} / \text{Ø}75\text{mm} = 2x \text{ click!}$   
 $\text{Ø}90\text{mm} = 3x \text{ click!}$

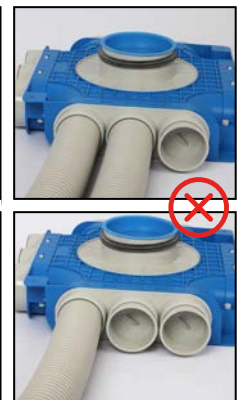
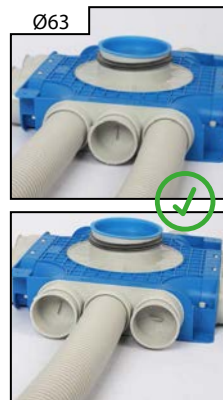

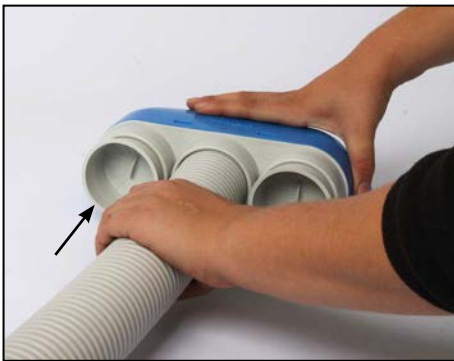
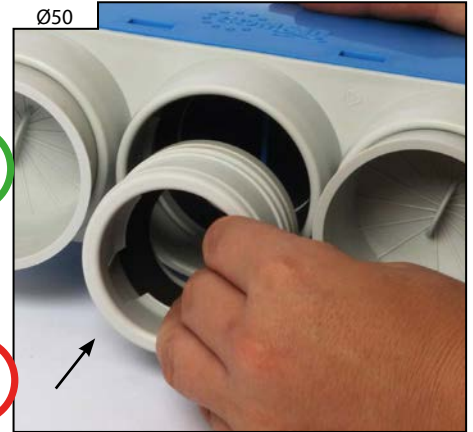
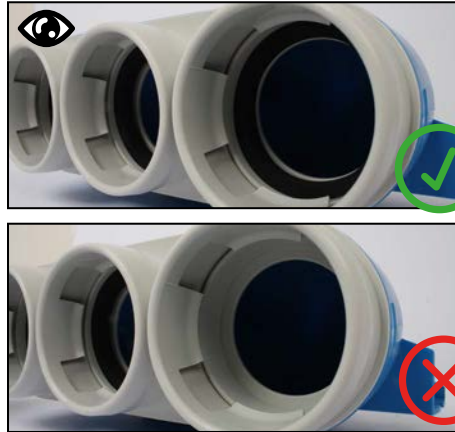
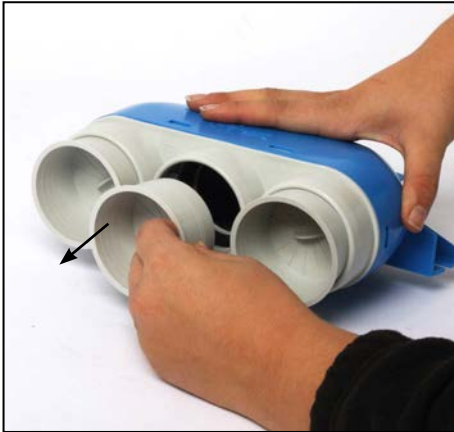

$\varnothing 50\text{mm} =$  + 2x click!  
 $\varnothing 63\text{mm} / \varnothing 75\text{mm} =$  2x click!  
 $\varnothing 90\text{mm} =$  3x click!

